

SYNTHESI

Tecnologia evoluta a servizio dell'uomo



Valsay
SISTEMAS DE EMBALAJE

ATLANTA
S T R E T C H

SYNTHEsi

- Synthesi si caratterizza per l'utilizzo e l'applicazione del film estensibile già prestirato e per le sue funzioni semplificate.
- Synthesi wird durch den Gebrauch von Vorgehnter Stretchfolien und das Bedienpult mit einfacher Funktionen gekennzeichnet.
- Synthesi is characterised by the use and application of already pre-stretch film and its simplified functions.
- Synthesi se caracteriza por la utilización y aplicación de film pre-estirado y por su simplificación de funciones.
- Synthési se caractérise pour l'utilisation et l'application de film pré-étiré et par ses fonctions simples mais complètes.

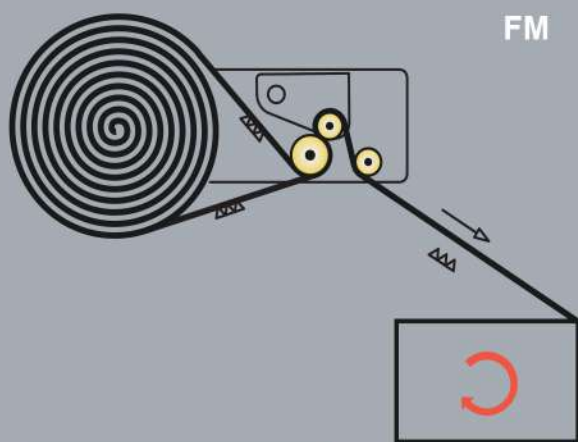
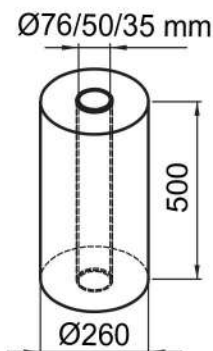

FM

- Frizione meccanica regolabile manualmente.
- Mechanical friction manually adjustable.
- Frein mécanique Réglage manuel.
- Mechanische Bremse auf Umlenkwalze.
- Fricción mecánica regulable manualmente.

350 Kg

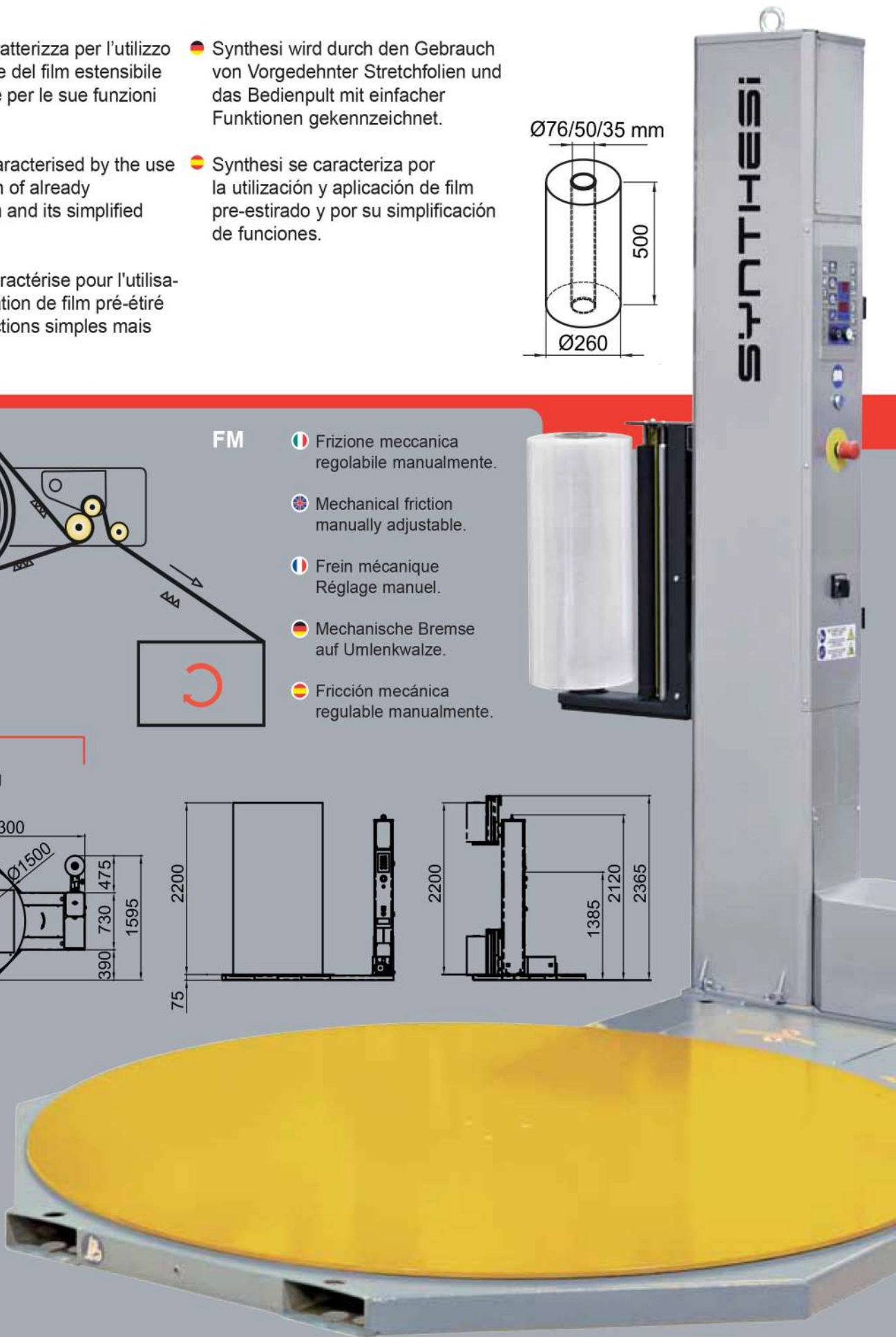
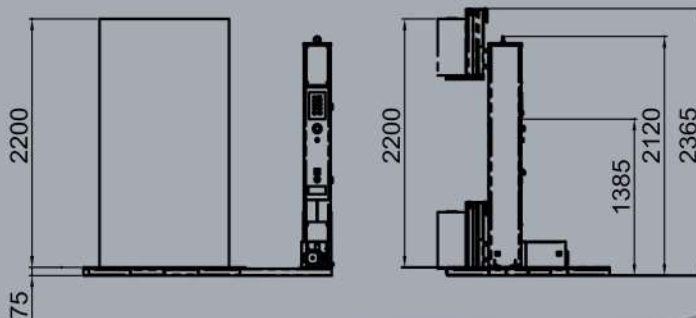
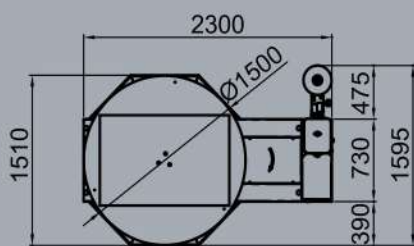

SYNTHESI TP

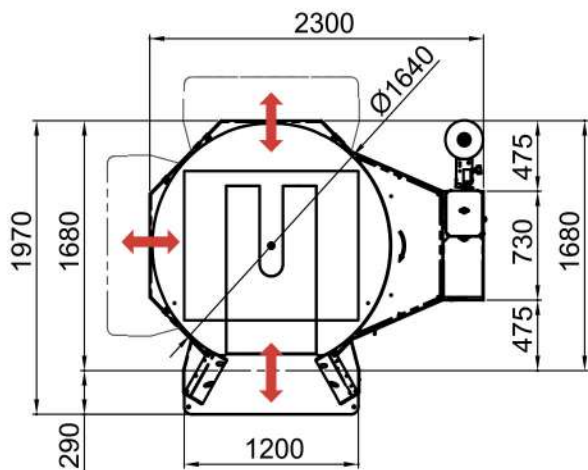

Versione transpallet a 3 vie di carico.

Transpallet version with 3 in feed.

Version transpalette 3 voies.

Ausführung Transpallet mit 3 ladenmöglichkeiten.

Versión traspaleta 3 posiciones de carga.

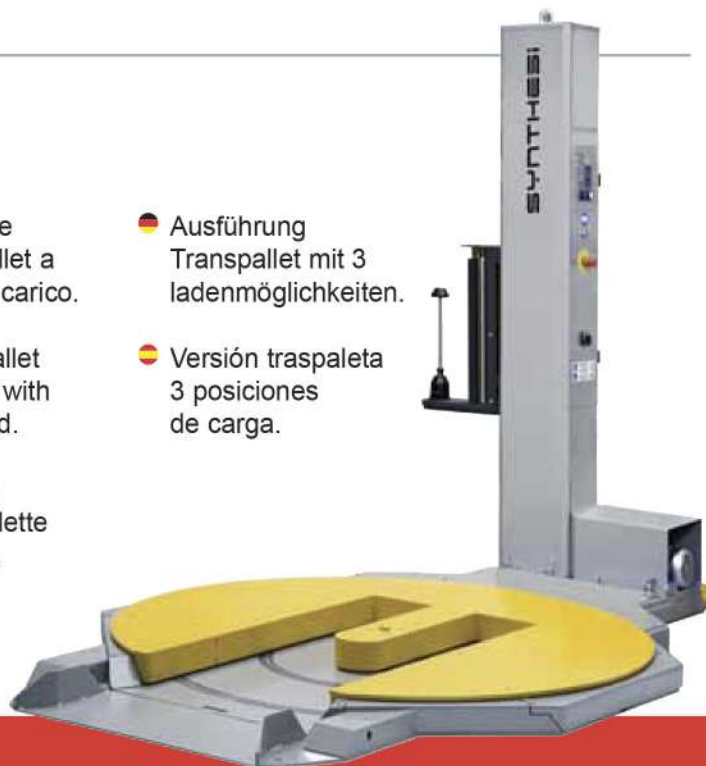

Parametri facilmente regolabili tramite pannello.

- Velocità di rotazione tavola.
- Possibilità di regolazione velocità salita e discesa carrello differenziata.
- Programmazione separata giri alti e bassi.
- Fotocellula lettura altezza pallet.
- Ciclo salita / salita e discesa.
- Ciclo mettifoglio.
- Cicli manuali:
Rotazione tavola,
Salita e discesa carrello portabobina.

Parameters easily adjustable from the panel.

- Table rotation speed.
- Carriage ascent and descent.
- Separate programming for high and low rpm.
- Pallet height photoelectric cell reading.
- Ascent / Ascent and Descent cycle.
- Sheet placement cycle.
- Manual cycles:
Table rotation,
Roll carriage ascent and descent.

Paramètres ajustables au pupitre

- Vitesse de rotation de la table.
- Vitesse de déplacement du chariot.
- Tours droits haut et bas séparés.
- Débordement supérieur du film.
- Cycle montée et descente.
- Cycle montée et descente seule.
- Cycle dépose de coiffe.
- Cycles manuels:
Rotation table
Montée/arrêt du chariot
Descente /arrêt du chariot.

Einstellbare Parameter von Bedienungstafel:

- Stufenlos regelbare Drehtellergeschwindigkeit.
- Stufenlos regelbare Hubschlittengeschwindigkeit.
- Einstellbare Anzahl für Fuß- und Kopfwicklungen.
- Fotozelle zur selbständigen Höhenabfrage.
- Kreuzspiral und Spiral.
- Regendichtprogramm
- Manueller Zyklusablauf:
Drehtellerdrehung.
Hubschlitten Auf- und Abwärts.

Parámetros fácilmente regulables mediante panel.

- Velocidad de rotación mesa.
- Subida y bajada carro.
- Programación separada de vueltas arriba y abajo.
- Fotocélula lectura altura palet.
- Ciclo subida / subida y bajada.
- Ciclo lámina cubre.
- Ciclos manuales:
Rotación mesa.
Subida y bajada carro porta bobina.



NEW

Pannello di controllo a multifunzione programmabile.

Multifunction programmable control panel.

Panneau de contrôle multifonction programmable.

Multifunktion programmierbare Systemsteuerung.

Panel de control programable multifunción.

Dati Tecnici	SYNTHEsi	SYNTHEsi TP
Potenza totale installata	0.85 Kw	0.85 Kw
Tensione alimentazione standard	230V monofase - 50/60 Hz	230V monofase - 50/60 Hz
Protezione impianto elettrico e motori	IP 54	IP 54
Dimensione max pallet	800 x 1200 mm	1000 x 1200 mm
Altezza std pallet	2200 mm	2200 mm
Portata max	1500 Kg	1200 Kg
Diametro tavola	1500 mm	1640 mm

Technical Characteristics	SYNTHEsi	SYNTHEsi TP
Total installed power	0.85 Kw	0.85 Kw
Standard input voltage	230V mono-phase - 50/60 Hz	230V mono-phase - 50/60 Hz
Electrical system and motors protection	IP 54	IP 54
Max pallet dimensions	800 x 1200 mm	1000 x 1200 mm
Standard pallet height	2200 mm	2200 mm
Max capacity	1500 Kg	1200 Kg
Table diameter	1500 mm	1640 mm

Données Techniques	SYNTHEsi	SYNTHEsi TP
Puissance totale installée	0.85 Kw	0.85 Kw
Tension alimentation standard	230V mono-phase - 50/60 Hz	230V mono-phase - 50/60 Hz
Protection installation électrique et moteurs	IP 54	IP 54
Dimensions maximum palette	800 x 1200 mm	1000 x 1200 mm
Hauteur standard palette	2200 mm	2200 mm
Portée maximum	1500 Kg	1200 Kg
Diamètre de la table	1500 mm	1640 mm

Technische Daten	SYNTHEsi	SYNTHEsi TP
Gesamte Leistung	0.85 Kw	0.85 Kw
Anschluss-Spannung	230V mono-phase - 50/60 Hz	230V mono-phase - 50/60 Hz
Elektroanlage und Motore Schutzart	IP 54	IP 54
Max. Palettenabmessung	800 x 1200 mm	1000 x 1200 mm
Max. Standard Wickelhöhe	2200 mm	2200 mm
Max. Ladungsgewicht	1500 Kg	1200 Kg
Drehteller Durchmesser	1500 mm	1640 mm

Datos Técnicos	SYNTHEsi	SYNTHEsi TP
Potencia total instalada	0.85 Kw	0.85 Kw
Tensión de alimentación estándar	230V mono-phase - 50/60 Hz	230V mono-phase - 50/60 Hz
Protección montaje eléctrico y motores	IP 54	IP 54
Dimensión máx palet	800 x 1200 mm	1000 x 1200 mm
Altura estándar palet	2200 mm	2200 mm
Peso máx	1500 Kg	1200 Kg
Diámetro mesa	1500 mm	1640 mm

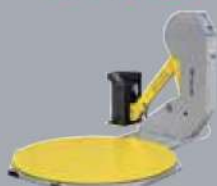
SFERA**MYTHO****MYTHO-A****REVOLUTION****OMEGA**

Valsay Sistemas de Embalaje S.L.

Pol. Industrial La Nava, Calle A-9

31300. Tafalla, Navarra

☎ 948 71 23 71

✉ valsay@valsay.com

🛒 www.valsay.com

